

Kensington®

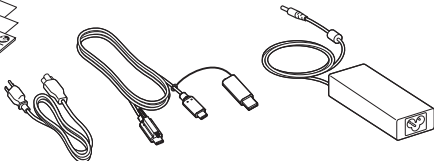

SD4782P USB-C & USB-A Dual 4K Docking Station with 100W Power Splitter
Station d'accueil double 4K USB-C et USB-A SD4782P avec répartiteur de puissance 100 W

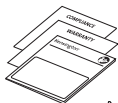
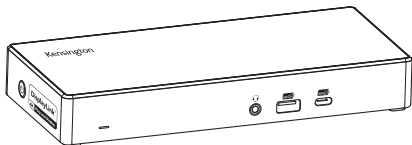

100W Power Splitter / Répartiteur d'alimentation 100W

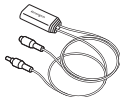
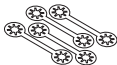
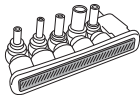

[kensington.com/register](https://www.kensington.com/register)

1

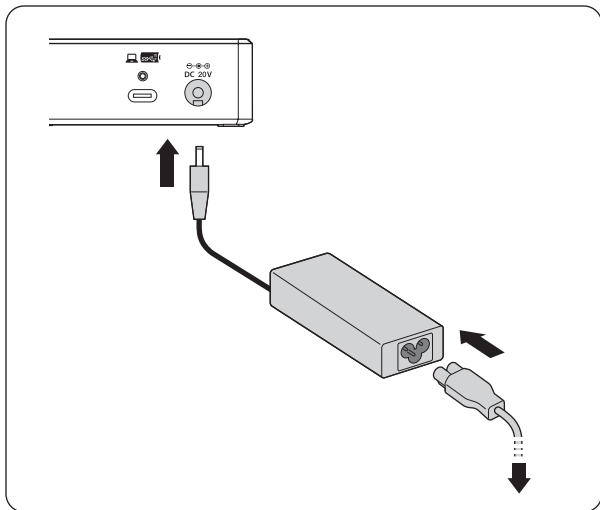

US

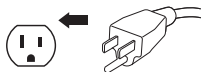

2

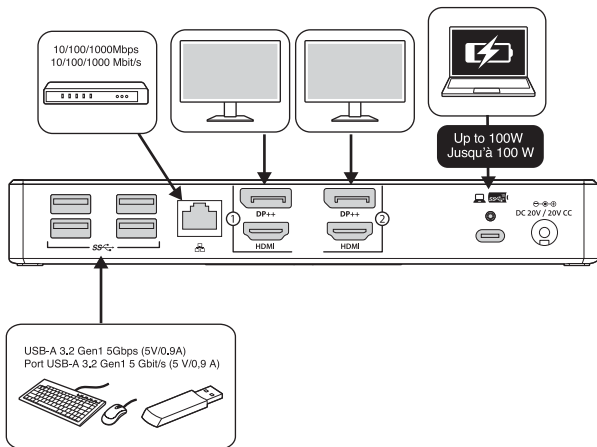
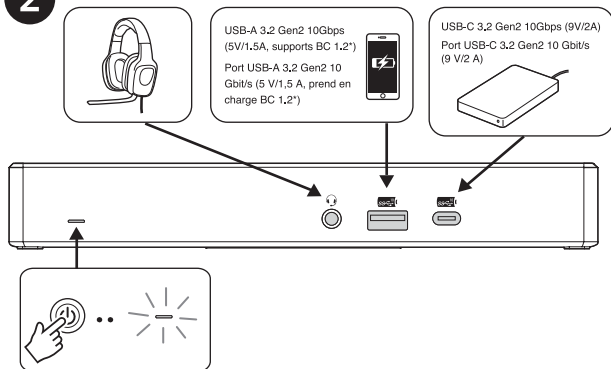

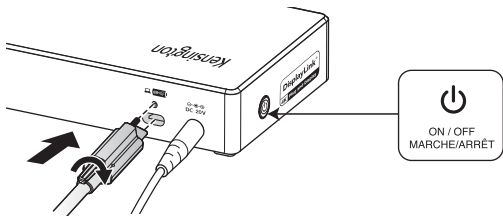

3

a

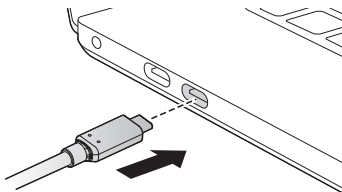

b

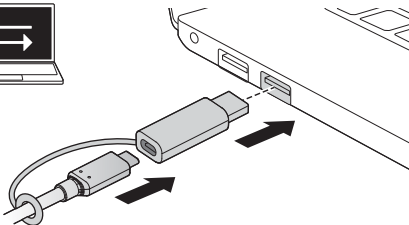

4

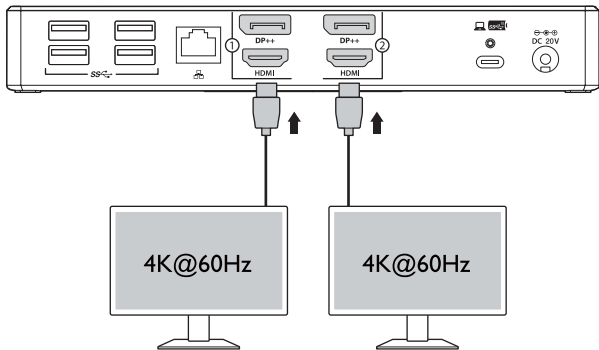
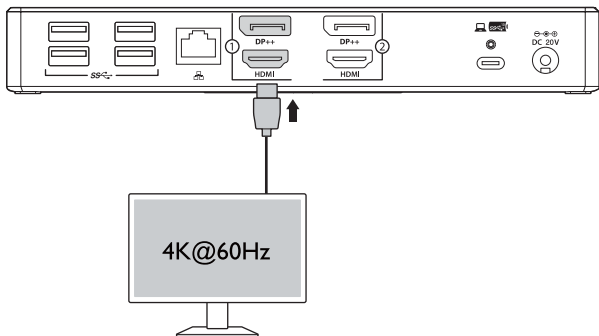

5

Windows 10 / macOS / Chrome OS

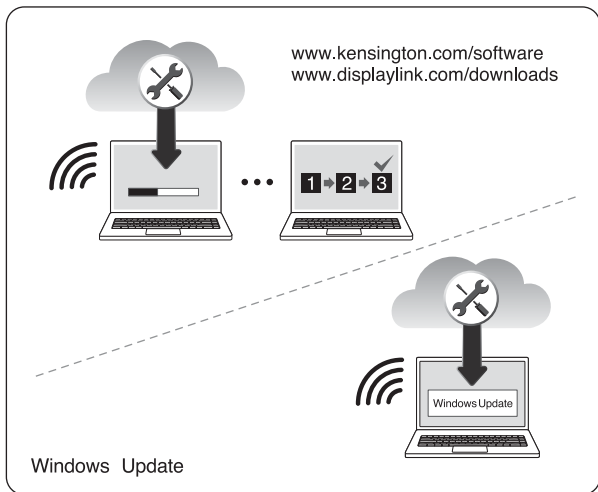

www.kensington.com/support

Sold separately / Vendu séparément

1

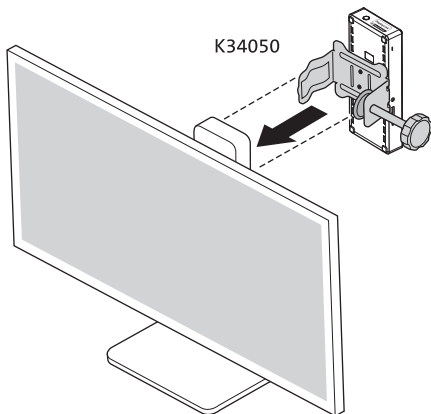

2

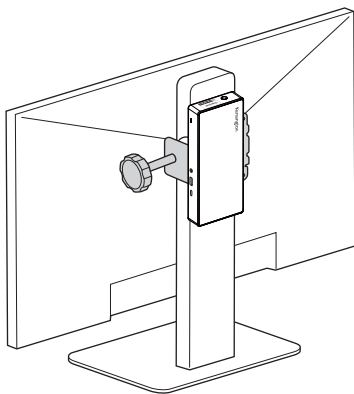

Sold separately
Vendu séparément

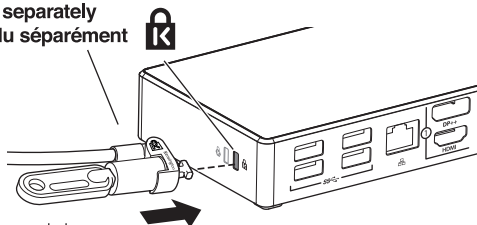

Recommended

K65020WW MicroSaver® 2.0 Keyed Laptop Lock

K65020WW MicroSaver® recommandé Serrure à clé pour ordinateur portable 2.0

Sold separately
Vendu séparément

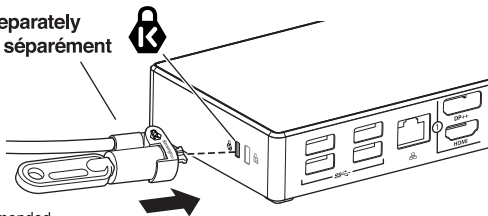

Recommended

K65021WW Slim NanoSaver® 2.0 Keyed Laptop Lock

K65021WW Slim NanoSaver® recommandé Serrure à clé pour ordinateur portable 2.0

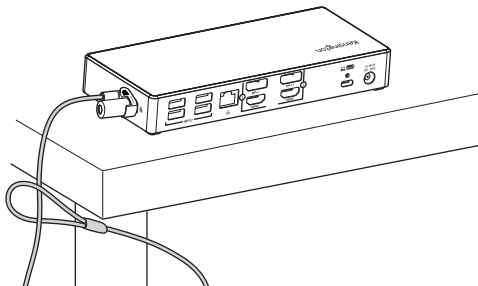



1

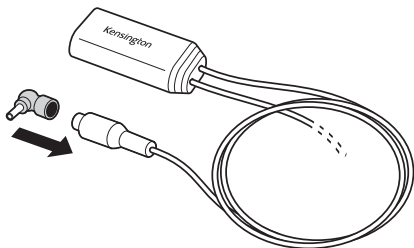

	Commonly used by the following laptop brands Couramment utilisé par les marques d'ordinateurs portables suivantes
A	*
C	Dell
D1	Lenovo
H	HP
I	HP
E	Dynabook & Toshiba

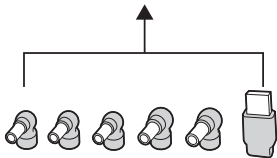

EN * Most Notebooks

FR * La plupart des ordinateurs portables

K33650NA included / K33650NA inclus

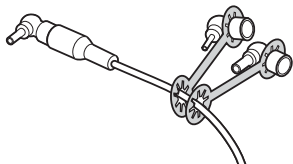

2

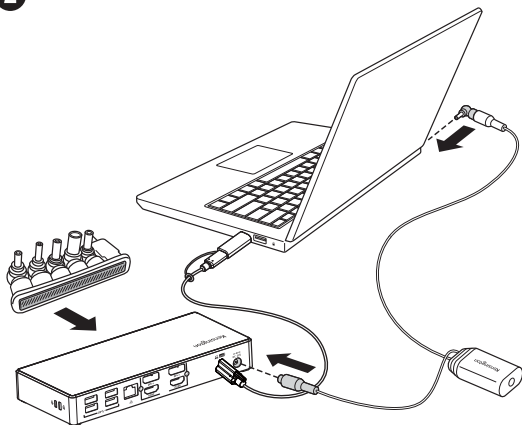

3

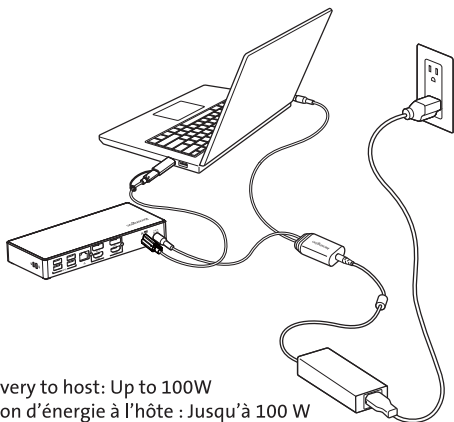
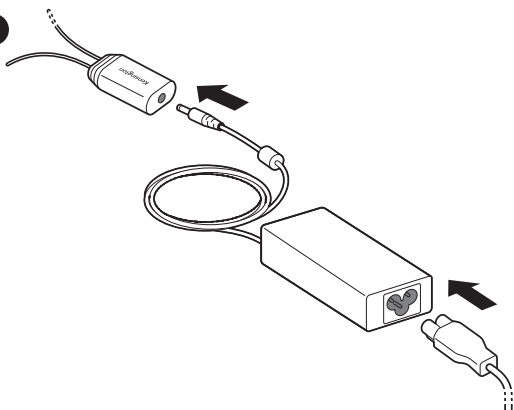

Power Delivery to host: Up to 100W

Transmission d'énergie à l'hôte : Jusqu'à 100 W



www.kensington.com/support

Kensington® is a registered trademark of ACCO Brands. All other registered and unregistered trademarks are the property of their respective owners.

© 2023 Kensington Computer Products Group, a division of ACCO Brands.

Patents: <https://www.accobrand.com/patents/>

Kensington® est une marque déposée d'ACCO Brands. Toutes les autres marques déposées et non déposées sont la propriété de leurs détenteurs respectifs.

© 2023 Kensington Computer Products Group, une division d'ACCO Brands.

Brevets : <https://www.accobrand.com/patents/>



K33650

901-8269-00